

# YAMAHA TX-670RDS

*Natural Sound AM/FM Stereo Tuner*

*Syntonisateur AM/FM stéréo de la série "Natural Sound"*

*"Natural Sound" MW/UKW-Stereo-Tuner*

*Natural Sound AM/FM stereotuner*

*Sintonizzatore stereo AM/FM a suono naturale*

*Sintonizador estéreo de AM/FM de sonido natural*

*Natural Sound Stereo Tuner*

OWNER'S MANUAL  
MODE D'EMPLOI  
BEDIENUNGSANLEITUNG  
BRUKSANVISNING  
MANUALE DI ISTRUZIONI  
MANUAL DE INSTRUCCIONES  
GEBRUIKSAANWIJZING

**SUPPLIED ACCESSORIES**  
**ACCESSOIRES FOURNIS**  
**MITGELIEFERTE ZUBEHÖRTEILE**  
**MEDFÖLJANDE TILLBEHÖR**  
**ACCESSORI IN DOTAZIONE**  
**ACCESORIOS INCLUIDOS**  
**BIJGELEVERDE ACCESSOIRES**

- After unpacking, check that the following parts are contained.
- Après le déballage, vérifier que les pièces suivantes sont incluses.
- Nach dem Auspacken überprüfen, ob die folgenden Teile vorhanden sind.
- Kontrollera efter det apparaten packats upp att följande delar finns med.
- Verificare che tutte le parti seguenti siano contenute nell'imballaggio dell'apparecchio.
- Desembale el aparato y verificar que los siguientes accesorios están en la caja.
- Controleer na het uitpakken of de volgende onderdelen voorhanden zijn.

- AM Loop Antenna/Indoor FM Antenna
- Cadre-antenna AM/Antenne FM intérieure
- MW-Rahmenantenne/UKW-Innenantenne
- AM ramantenn/FM inomhusantenn
- Antenna AM ad anello/Antenna FM per interni
- Antena de cuadro de AM/Antena FM interior
- AM Lusantenne/FM Binnenantenne

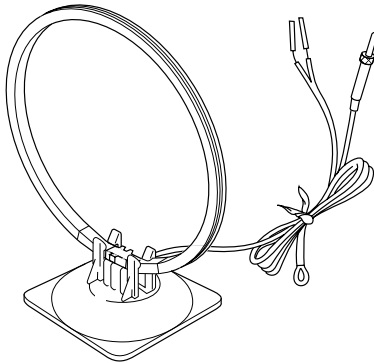

(U.K. model)  
 (Modèle pour le Royaume-Uni)  
 (Großbritannien-Modell)  
 (Brittisk modell)  
 (Modello per la Gran Bretagna)  
 (Modelo para R.U.)  
 (Modellen voor Groot-Brittannië)

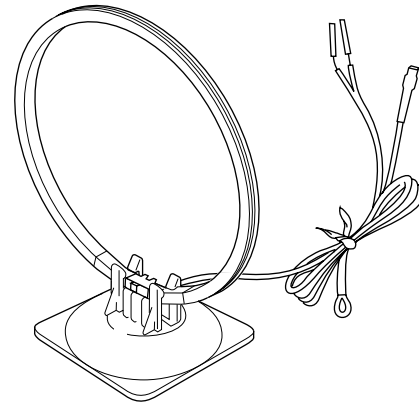

(Europe model)  
 (Modèle pour l'Europe)  
 (Europa-Modell)  
 (Europeisk modell)  
 (Modello per l'Europa)  
 (Modelo para Europa)  
 (Modellen voor Europa)

- Audio connection cord
- Câble de connexion audio
- Audio-Anschlusskabel
- Audio anslutningsladdar
- Cavo di collegamento audio
- Cable de conexión de audio
- Audio aansluitkabel

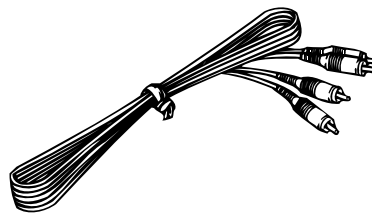

## FEATURES

- Multi-Functions for RDS Broadcast Reception
- 40 Station Random Access Preset Tuning
- Manual Station Name Input Capability
- Automatic Preset Tuning for RDS Stations
- Multi-Status Station Memory
- Rotary Encoder Tuning
- Direct PLL Synthesizer Tuning
- 2-Position IF Mode Select Button
- BLEND Button
- Remote Control Capability (Optional)

## CONTENTS

Supplied Accessories.....	2
Caution.....	3
Connections .....	4
Tuning Operations .....	7
Preset Tuning.....	9
Receiving RDS Stations.....	13
Remote Control Transmitter (Separate purchase).....	18
Troubleshooting .....	19
Specifications.....	20

## CAUTION: READ THIS BEFORE OPERATING YOUR UNIT.

1. This unit is a sophisticated stereo tuner. To assure proper operation and the best possible performance, please read this manual carefully.
2. Choose the installation location for the unit carefully. Avoid placing it in direct sunlight or close to a source of heat. Also avoid locations subject to vibration and excessive dust, heat, cold or moisture. Keep it away from such sources of hum as transformers or motors.
3. Do not open the cabinet, because this may result in damage to the unit or electrical shock. If a foreign object should get into the unit, contact your local dealer.
4. When not planning to use this unit for long periods of time (ie., vacation, etc.), disconnect the AC power plug from the wall outlet.
5. To prevent lightning damage, disconnect the AC power plug and disconnect the antenna cable when there is an electrical storm.
6. When disconnecting the power plug from the wall outlet, always pull directly on the plug; never pull the cord itself.
7. Do not use force when operating switches and other controls.
8. When moving the unit, be sure to first disconnect the power plug and disconnect all wires connected from the unit to other equipment.
9. Do not attempt to clean this unit with chemical solvents, because this may damage the finish. Use a clean, dry cloth.
10. Be sure to read the "TROUBLESHOOTING" section of this manual for advice on common operating errors before concluding that the unit is faulty.
11. Keep this manual in a safe place for future reference.

### IMPORTANT

Please record the serial number of this unit in the space below.

### Serial No.:

The serial number is located on the rear of the unit. Retain this Owner's Manual in a safe place for future reference.

### WARNING

TO REDUCE THE RISK OF FIRE OR ELECTRIC SHOCK, DO NOT EXPOSE THIS APPLIANCE TO RAIN OR MOISTURE.

### CAUTION

The power switch does not disconnect the complete apparatus from the mains line.

### For U.K. customers

If the socket outlets in the home are not suitable for the plug supplied with this appliance, it should be cut off and an appropriate 3 pin plug fitted. For details, refer to the instructions described below.

**Note:** The plug severed from the mains lead must be destroyed, as a plug with bared flexible cord is hazardous if engaged in a live socket outlet.

### Special Instructions for U.K. Model

### IMPORTANT

THE WIRES IN THE MAINS LEAD ARE COLOURED IN ACCORDANCE WITH THE FOLLOWING CODE:

Blue: NEUTRAL  
Brown: LIVE

The colours of the wires in the mains lead of this apparatus may not correspond with the coloured markings identifying the terminals in your plug. Proceed as follows: the wire which is coloured BLUE must be connected to the terminal which is marked with the letter N or coloured BLACK. The wire which is coloured BROWN must be connected to the terminal which is marked with the letter L or coloured RED. Making sure that neither core is connected to the earth terminal of the three pin plug.

# CONNECTIONS

## ANTENNA CONNECTIONS

- Each antenna should be connected to the designated terminals correctly, referring to the following figure.
- Both AM and FM indoor antennas are included with this unit. In general, these antennas will probably provide sufficient signal strength. Nevertheless, a properly installed outdoor antenna will give clearer reception than an indoor one. If you experience poor reception quality, an outdoor antenna may result in improvement.

### U.K. MODEL

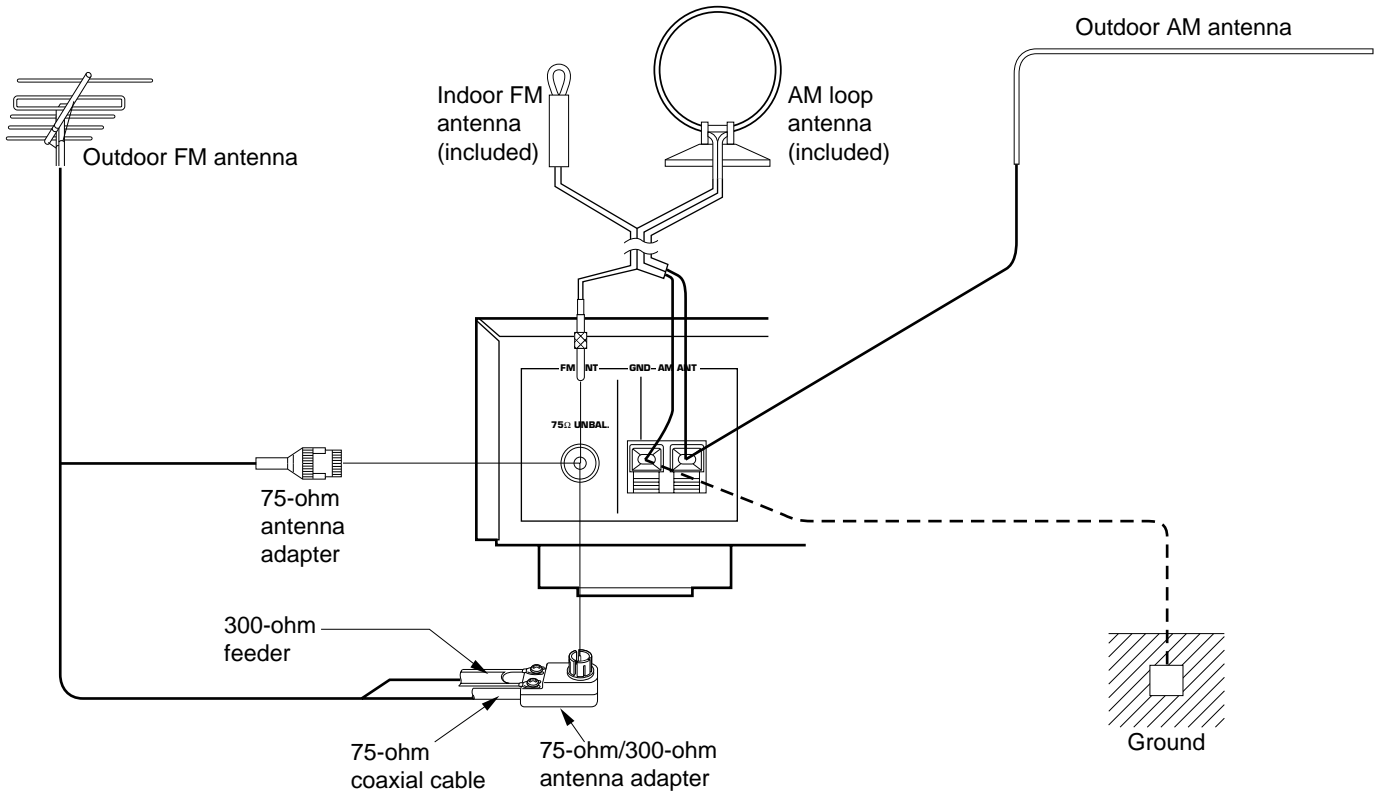

### EUROPE MODEL

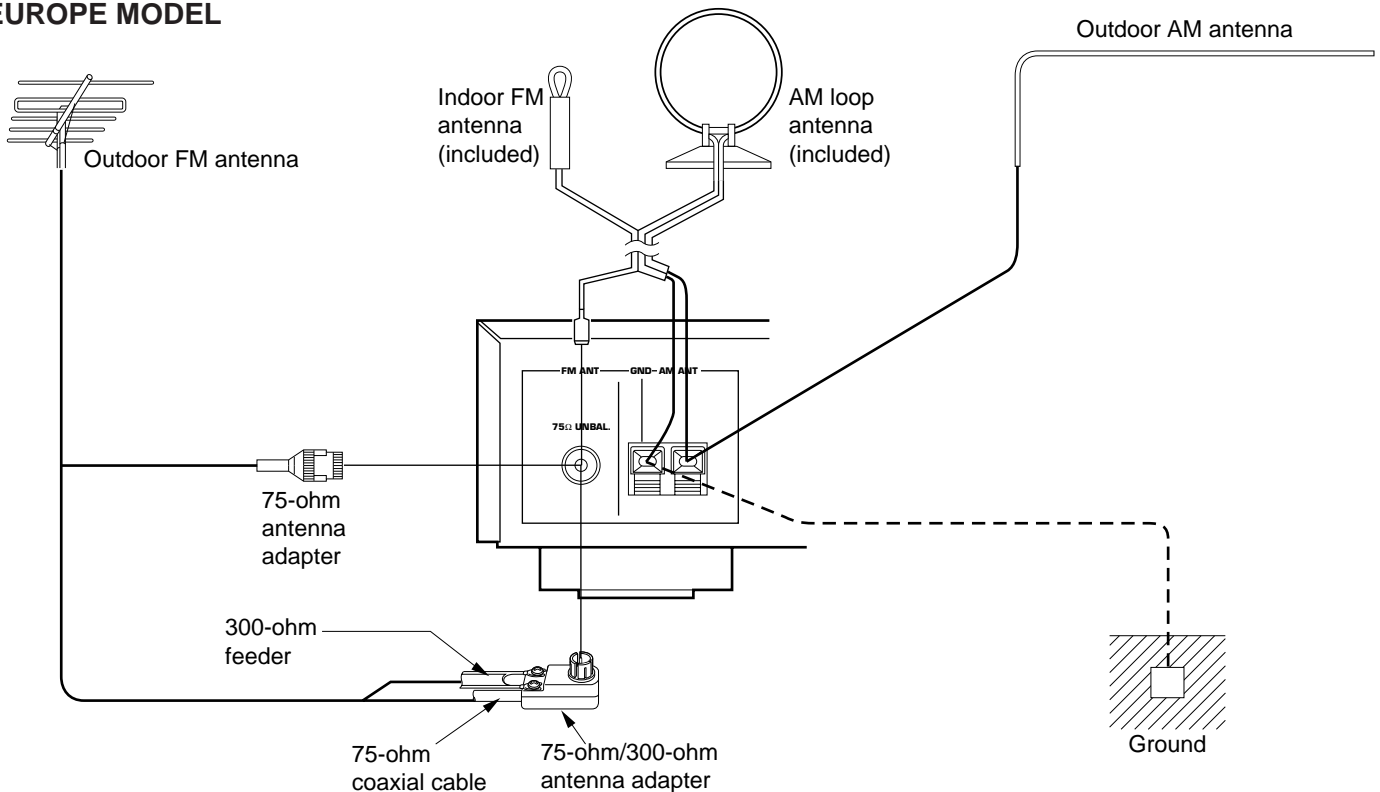

**Connecting the indoor FM antenna**

(U.K. model)

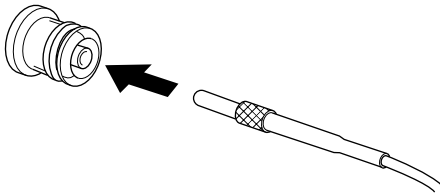

(Europe model)

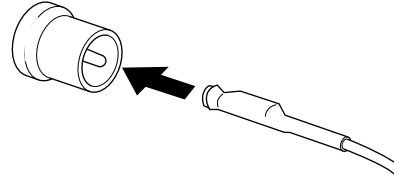

\* If you connect an outdoor FM antenna to this unit, do not connect the indoor FM antenna to this unit.

**Connecting the AM loop antenna**

1

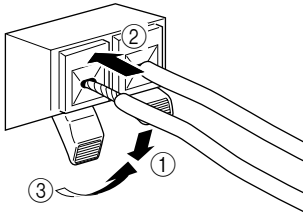

2

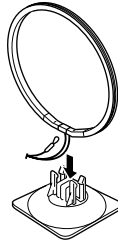

3

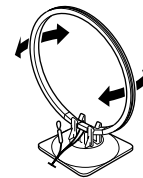

Orient so that the best reception is obtained.

\* The AM loop antenna should be placed apart from the main unit. The antenna may be hung on a wall.

\* The AM loop antenna should be kept connected, even if an outdoor AM antenna is connected to this unit.

**Positioning of the AM loop antenna/indoor FM antenna**

After the connections, place the indoor FM antenna to the position where the best reception is obtained, and next, orient the AM loop antenna so that the best reception is obtained. However, if the orientation of the AM loop antenna moves the pre-positioned indoor FM antenna, you can separate the antennas with your hands easily and place each antenna to the best position.

**Optional outdoor FM antenna**

Consult with your dealer or authorized service center about the best method of selecting and erecting an outdoor FM antenna. The choice of the feeder cable is also important. Flat ribbon-shaped twin-lead cable performs well electrically, and is cheaper and somewhat easier to handle when routing it through windows and around rooms. Coaxial cable is more expensive, does a much better job of minimizing interference, is less prone to the effects of weather and close-by metal objects, and is nearly as good a signal conductor as feeder cable, particularly for foam-type coaxial cables. Coaxial cable is somewhat more difficult to install at the point where the cable enters the building. If coaxial cable is selected, make sure the antenna is designed to be used with that type of cable.

\* Use a 75-ohm/300-ohm antenna adapter (not included) or a 75-ohm antenna adapter (not included) for connections.

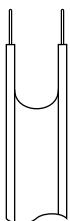
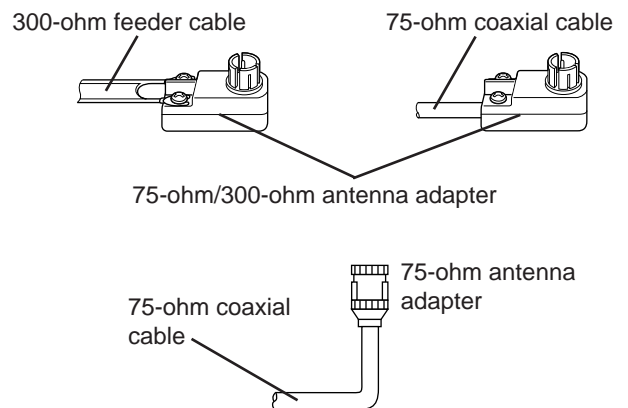

300-ohm feeder cable

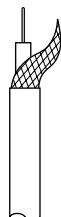

75-ohm coaxial cable

**Notes for FM antenna installation**

- To minimize automobile ignition noise, locate the antenna as far from heavy traffic as possible.
- Keep the feeder cable or coaxial cable as short as possible. Do not bundle or roll up excess cable.
- The antenna should be at least two meters (6.6 feet) from reinforced concrete walls or metal structures.

## ■ Optional outdoor AM antenna

In steel buildings or at a great distance from the transmitter, it may be necessary to install an outside long wire antenna.

### GND terminal

For maximum safety and minimum interference, connect the **GND** terminal to a good earth ground. A good earth ground is a metal stake driven into moist earth.

## CONNECTIONS TO THE AMPLIFIER

- Before making any connections, switch OFF the power to this unit and the amplifier or other component.
- Be sure that the connections from the left ("L") and right ("R") OUTPUT terminals are connected to the corresponding (left and right) input terminals of the amplifier or other component.

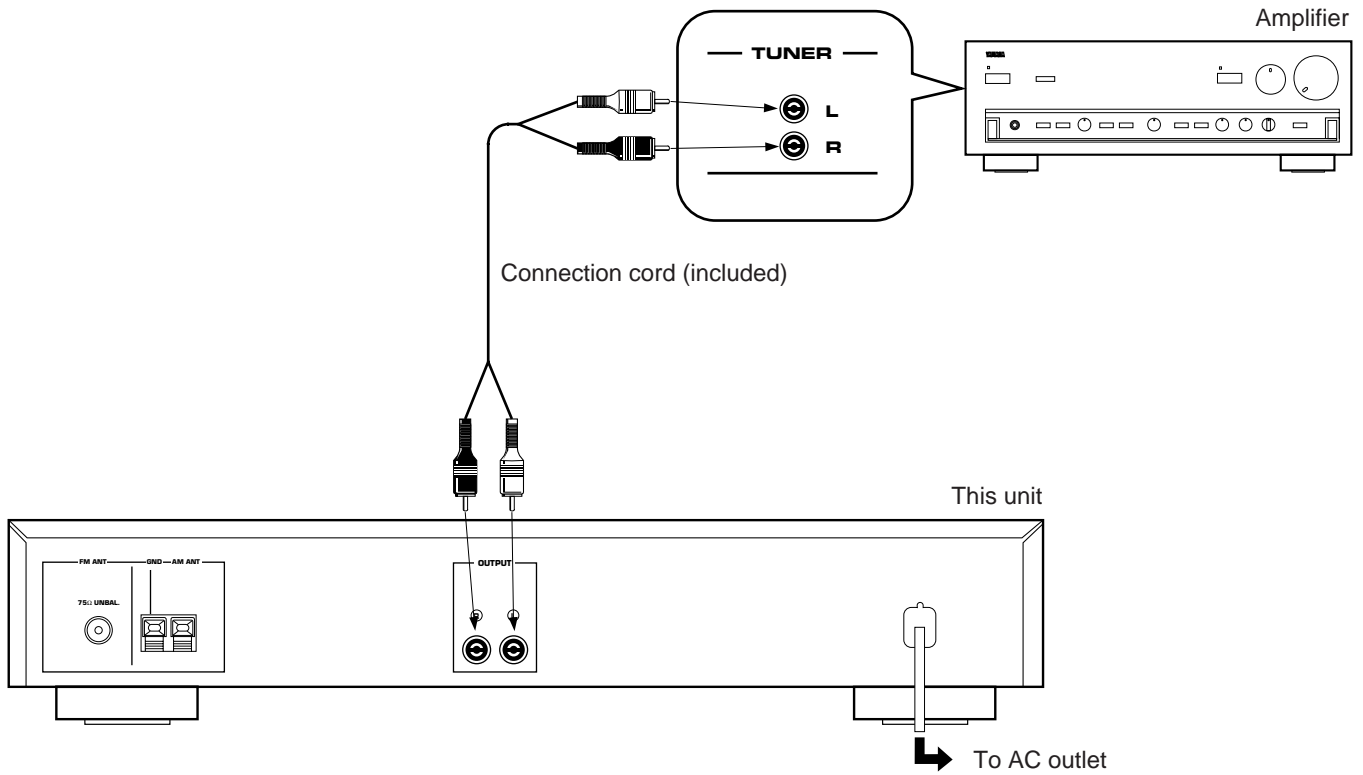

\* This unit has a remote control sensor. It receives signals from the separately purchased remote control transmitter or a remote control transmitter provided with a YAMAHA amplifier.

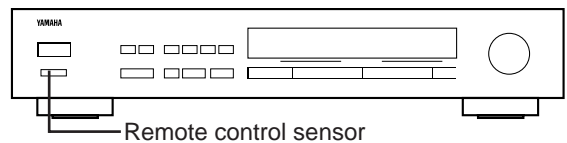



# TUNING OPERATIONS

Normally, if station signals are strong and there is no interference, quick automatic-search tuning (AUTOMATIC TUNING) is possible. However, if signals of the station you want to select are weak, you must tune to it manually (MANUAL TUNING).

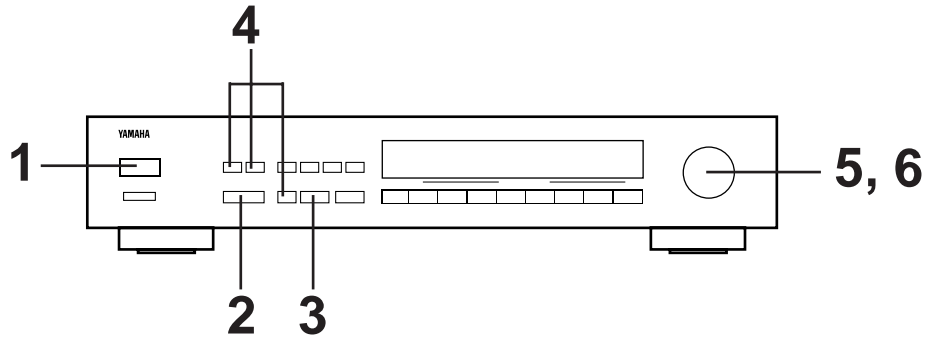
## AUTOMATIC TUNING

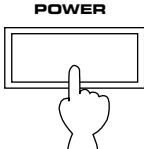

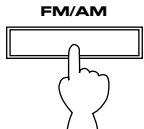
**1** 

**2** Select the reception band (FM or AM) while watching the display.  
 →  or 

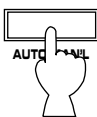
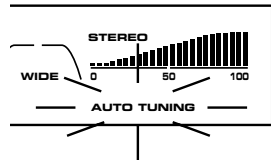
**3**  → 

**4** For FM reception, set the **MODE**, **BLEND** and **IF MODE** buttons as desired. (Refer to page 8 for details.)

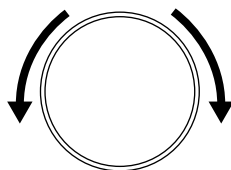
**5** Tune to a desired station.  
  
 To tune to a higher frequency, slightly turn the control to the right. To tune to a lower frequency, slightly turn the control to the left.

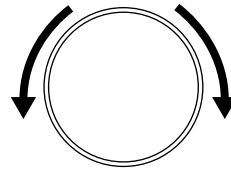
**6** If the station where tuning search stopped is not the desired one, follow step 5 again.  

\* If the tuning search does not stop at the desired station, change to the MANUAL TUNING method as described on the following page.

## Display information

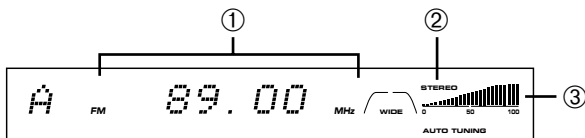

- ① Displays the band and frequency of the received station.  
 \* If an RDS station is received, the frequency is then replaced by the station name. (However, if the PS data cannot be received within 5 seconds, "NO PS" flashes, and then it returns to the frequency display.) Refer to page 14 for details.
- ② Illuminates when an FM stereo broadcast is received in stereo.
- ③ Indicates the signal level of the received station.

# MANUAL TUNING

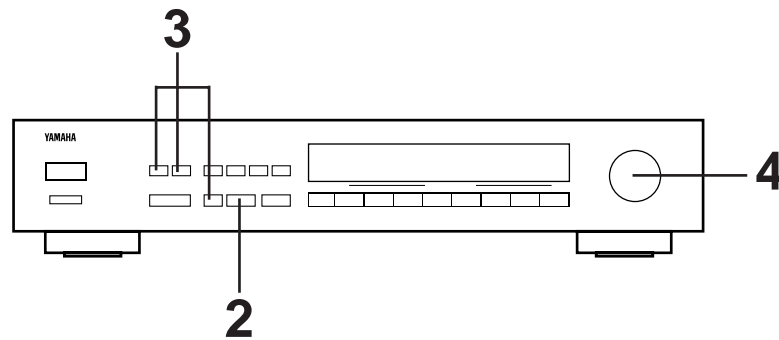

**1** Follow steps 1 and 2 on the previous page.

**2**

TUNING MODE  
AUTO TUNING

STEREO  
WIDE 0 50 100

"AUTO TUNING" goes off.

**3** For FM reception, set the **MODE**, **BLEND** and **IF MODE** buttons as desired.

**4** Tune to a desired station manually.

## Other functions to improve FM reception signal quality

### MODE button

Normally, press this button so that the "AUTO ST" indicator illuminates. When receiving an FM stereo broadcast in this mode, it is received in stereo automatically.

When receiving a weak FM broadcast, press this button so that the "AUTO ST" indicator goes out. It is received in monaural, however, you can obtain higher signal quality.

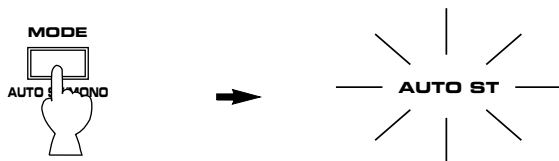

### BLEND button

If a noisy FM stereo broadcast is received, press this button so that the "BLEND" indicator illuminates. The left and right channels are blended accordingly to reduce the noise and improve the reception signal quality. When the **MODE** button is set to the monaural mode (so that the "AUTO ST" indicator does not illuminate), the BLEND function will not operate even if the BLEND indicator illuminates.

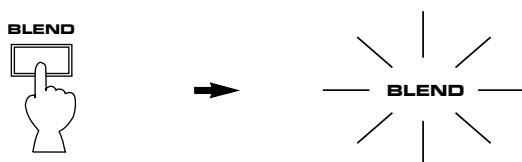

### IF MODE button

This button is used to vary the bandpass of the FM intermediate frequency (IF) between WIDE and NARROW.

If the reception signal is strong, press this button so that the "WIDE" indicator illuminates (to obtain distortion-free sound). When the reception signal is weak, or when the desired station is interfered with by adjacent stations, press this button so that the "NARROW" indicator illuminates (to increase the selectivity).

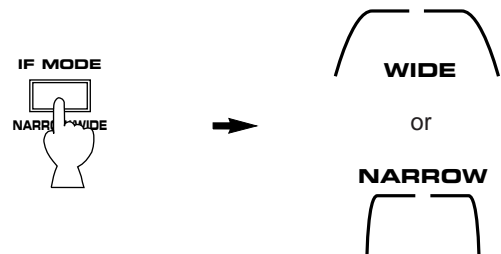



# PRESET TUNING

## MANUAL PRESET TUNING

This unit can store station frequencies (selected by tuning operation) by using the preset station buttons. With this function, you can select any desired station by only pressing the corresponding preset station button. Up to 40 stations (8 stations x 5 pages) can be stored.

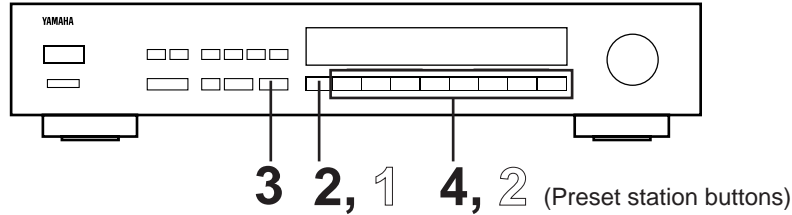

### To store stations

- 1** Tune to a desired station.  
(Refer to pages 7–8 for tuning procedure.)
- 2** Select a desired page (A – E) of preset station buttons while watching the display.
- 3**

Flashes on and off for about 5 seconds.
- 4** Press a preset station button before “MEMORY” goes off from the display.

Shows the displayed station has been programmed to A1.

\* In the same way, program other stations to A2, A3 ... A8.  
\* You can program more stations to the preset station buttons on other pages in the same way by selecting other pages in step 2.

### To recall a preset station

- 1** Select the page of preset station buttons.
- 2**

Select the desired preset station button.

#### Notes

- A new setting can be programmed in place of the former one.
- For FM reception, the settings of the **MODE**, **BLEND** and **IF MODE** buttons are stored along with the station frequency.

#### Memory back-up

The memory back-up circuit prevents the programmed data from being lost even if the **POWER** switch is set off or the power plug is disconnected from the AC outlet for more than 1 year.

#### For using an external timer

When making timer setting by using an external timer, store the station to be called onto A1, and be sure to turn the power off while the preset station on A1 is being called.

## To store stations with names of your own giving

You can store a station with a name of your own giving. As many as 8 letters and/or numerals can be selected for the naming. By using this function, you can easily find a certain station even if you are not sure of that station's frequency. You can give names to all preset stations.

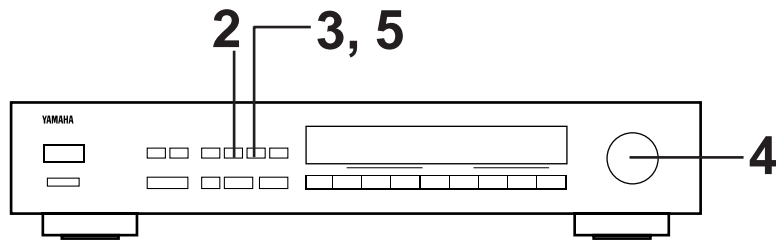

**1** Tune to a desired station.  
(Refer to pages 7–8 for tuning procedures.)

**2**

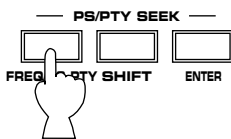

### In FM reception:

A station name is displayed or "NO PS" flashes.

\* If "NO PS" flashes, proceed to the next step while flashing. If "NO PS" disappears before proceeding to the next step, press the **FREQ/PS/PTY** button again.

### In AM reception:

"-----" flashes on the display.

**3**

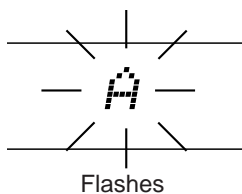
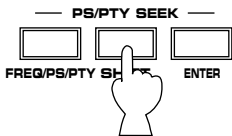

**4** Select the first letter or numeral to be memorized.

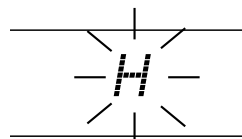
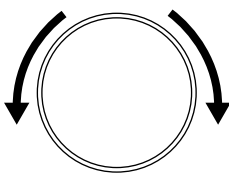

\* By turning the **TUNING** control, the display will change letters and numerals in sequence.

**5** When the desired letter or numeral appears, press the **SHIFT** button to proceed to the selection of the next letter or numeral.

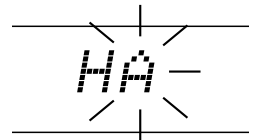
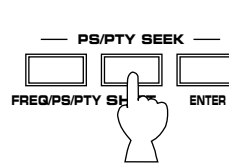

"A" will flash on the second letter or numeral position.

**6** Repeat steps 4 and 5 for the other letters and/or numerals, if necessary.

**7** After the naming is finished, follow steps 2–4 of "To store stations" on the previous page.

### Note

If you store a name to an RDS station which has PS data, the name of your giving takes priority and is shown on the display.

### Character table

The following letters, numerals and symbols are selected on this unit.

A	B	C	D	E	F	G	H	I	J	K	L	M	N	O	P	Q	R	S	T	U	V					
W	X	Y	Z	a	b	c	d	e	f	g	h	i	j	k	l	m	n	o	p	q	r	s	t	u	v	
w	x	y	z	,	-	.	/	0	1	2	3	4	5	6	7	8	9	:	;	á	à	é	è	í	ì	ó
ò	ú	û	â	ä	ê	ë	ï	î	ô	õ	ü	ñ	ç	ş	ğ	ä	Ö	Å	Ğ	ě	ň	Q	ã			
å	ń	_																								

"\_" indicates a blank space.

## AUTOMATIC PRESET TUNING

You can also make use of an automatic preset tuning function for RDS stations only. By this function, this unit performs automatic tuning and stores RDS stations with strong signals sequentially. Up to 40 stations are stored automatically to the preset station buttons in the same way as in the manual preset tuning method on page 9.

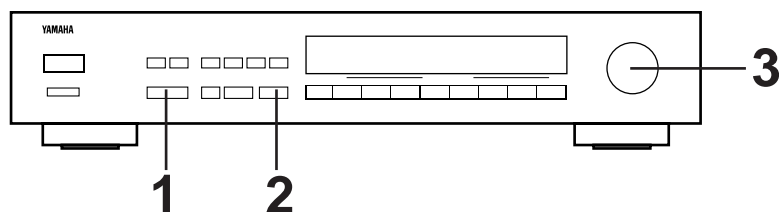

### To store stations

**1**

**2**

Press and hold for about 3 seconds.

Flashes.

**3**

Slightly turn the **TUNING** control to the right (or to the left).  
 \* When turned to the right, automatic tuning is performed toward higher frequencies. When turned to the left, automatic tuning is performed toward lower frequencies.

This unit performs automatic tuning and received RDS stations are programmed to A1, A2 ... A8 sequentially.  
 \* If more than 8 stations are received, they are also programmed to other pages (B, C, D and E) of preset station buttons in that order.

### After the automatic preset tuning is completed

The display shows the frequency of the last preset station. Check the contents and the number of preset stations by following the procedure of the section "To recall a preset station" on page 9.

### To recall a preset station

Simply follow the procedure of the section "To recall a preset station" on page 9. A recalled station is shown by the frequency or station name on the display.

### Notes

- The automatic preset tuning search will be performed through all RDS network frequencies until 40 stations are stored. If the number of received stations is less than 40, the search will stop after searching through all stations.
- With this function, the settings of the **MODE**, **BLEND** and **IF MODE** buttons are stored along with stations.
- With this function, only RDS stations with sufficient signal strength are stored automatically. If the station you want to program is weak in signal strength, tune to it in monaural manually and program it by following the procedure of the section "To store stations" on page 9.  
 \* There may be a case that this function cannot receive a station which could be received by the automatic tuning method. This is because this function receives a large volume of PI (Program Identification) data along with the station.
- You can replace a preset station by another FM or AM station manually by simply following the procedure of the section "To store stations" on page 9.

# EXCHANGING PRESET STATIONS

You can exchange the places of two preset stations each other by easy operations.

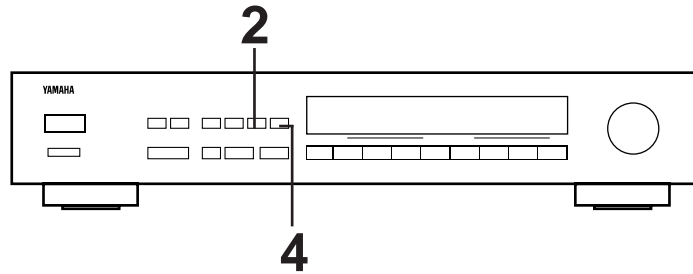

**Example)**

If you want to shift the preset station on E1 to A5, and vice versa.

**1** Recall the preset station on E1 (by following the method of "To recall a preset station" on page 9).

*E1 BBC R3*

**2**

PS/PTY SEEK

Press and hold for about 3 seconds.

↓

E1 - *BBC R3*  
MEMORY

Flashes.

**3** Next, recall the preset station on A5 by following the same method with step 1.

A5 FM - *103.90*  
MEMORY

Flashes.

**4**

PS/PTY SEEK

↓

E1 - A5  
MEMORY

Flashes.

After flashing is stopped, the exchange of stations is completed.

*A5 BBC R3*

# RECEIVING RDS STATIONS

RDS (Radio Data System) is a data transmission system gradually being introduced by FM stations in many countries. Stations using this system transmit an inaudible stream of data in addition to the normal radio signal.

RDS data contains various information, such as AF (Alternative Frequencies for the same program station), PI (Program Identification), PS (Program Service station name), PTY (Program Type name), etc.

RDS function is carried out among the network stations.

\* This unit utilizes AF, PI, PS and PTY to receive RDS broadcast stations.

## Displaying RDS data

This unit can be turned into the following two modes to display RDS data.

### PS (Program Service station name) mode:

Displays the name of the RDS station now being received instead of the frequency. **BBC R3**

### PTY (Program Type name) mode:

Displays the program type of the RDS station now being received. There are 15 program types to classify RDS stations as follows.

<b>NEWS</b>	<b>News:</b> Short accounts of facts, events and publicly expressed views, reportage and actuality.	<b>VARIED</b>	<b>Varied:</b> Used for mainly speech-based programs usually of light-entertainment nature, not covered by above categories. Examples are: quizzes, panel games, personality interviews, comedy and satire.
<b>AFFAIRS</b>	<b>Current affairs:</b> Topical program expanding or enlarging upon the news, generally in different presentation style or concept, including documentary debate, or analysis	<b>POP M</b>	<b>Pop:</b> Commercial music, which would generally be considered to be of current popular appeal, often featuring in current or recent record sales charts.
<b>INFO</b>	<b>Information:</b> Program whose purpose is to impart advice in the widest sense, including meteorological reports and forecasts, consumer affairs, medical help, etc.	<b>ROCK M</b>	<b>Rock:</b> Contemporary modern music, usually written and performed by young musicians.
<b>SPORT</b>	<b>Sport:</b> Program concerned with any aspect of sport.	<b>MOR M</b>	<b>M.O.R.:</b> (Middle of the Road Music). Common term to describe music considered to be "easy-listening", as opposed to Pop, Rock or Classical. Music in this category is often but not always, vocal, and usually of short duration (<5 min.)
<b>EDUCATE</b>	<b>Education:</b> Program intended primarily to educate, of which the formal element is fundamental.	<b>LIGHT M</b>	<b>Light classics:</b> Classical Musical for general, rather than specialist appreciation. Examples of music in this category are instrumental music, and vocal or choral works.
<b>DRAMA</b>	<b>Drama:</b> All radio plays and serials.	<b>CLASSICS</b>	<b>Serious classics:</b> Performances of major orchestral works, symphonies, chamber music etc., and including Grand Opera.
<b>CULTURE</b>	<b>Culture:</b> Programs concerned with any aspect of national or regional culture, including religious affairs, philosophy, social science, language, theatre, etc.	<b>OTHER M</b>	<b>Other music:</b> Musical styles not fitting into any of the above categories. Particularly used for specialist music, of which Jazz, Rhythm & Blues, Folk, Country, and Reggae are examples.
<b>SCIENCE</b>	<b>Science:</b> Programs about the natural sciences and technology.		

## To turn the unit into the PS mode or PTY mode

Press the **FREQ/PS/PTY** button. Whenever pressed, the mode changes into the PS mode, PTY mode and returns to usual mode in turn.

\* When an RDS station is received, the display is automatically turned into the PS mode.

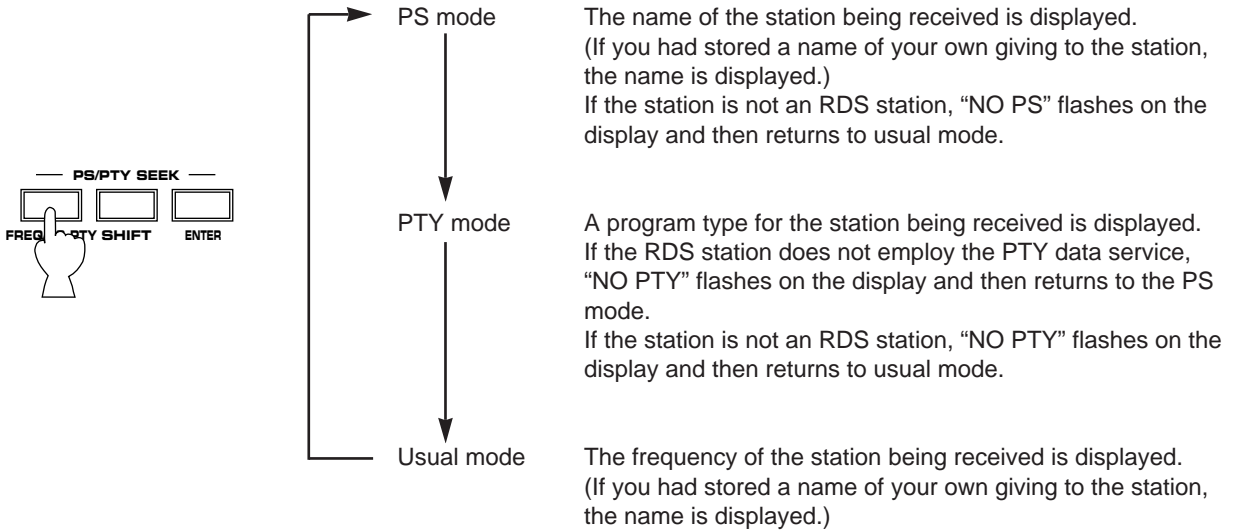

### Note

When PS or PTY data reception is not possible due to poor reception conditions, "NO PS" or "NO PTY" flashes on the display in each mode. In such a case, use the **BLEND**, **IF MODE** and/or **MODE** buttons to improve sound quality. After that, when you changes to the PS or PTY mode, PS or PTY data will be displayed.

## Calling a preset RDS station by the station name (PS SEEK)

You can call a desired RDS station stored in this unit by only inputting the name of the station in the PS mode. By this operation, this unit searches the station from among all preset stations. You do not have to input a full name, even only the first letter can be used for calling. As many as 8 letters and/or numerals can be selected for inputting a name.

\* If you had stored an FM station other than an RDS station with a name of your own giving, it can also be called by inputting the name.

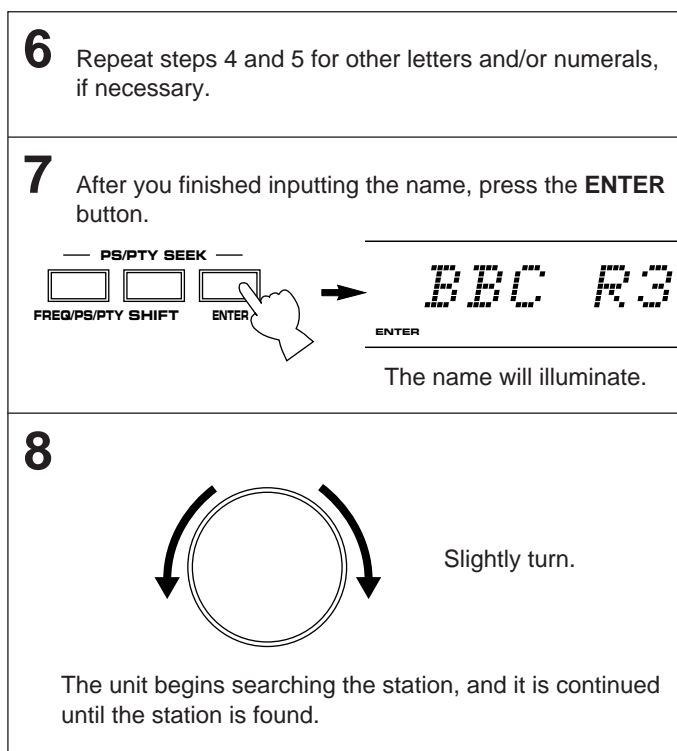
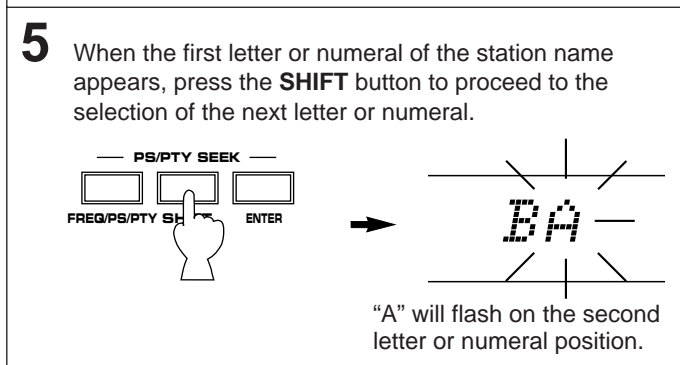
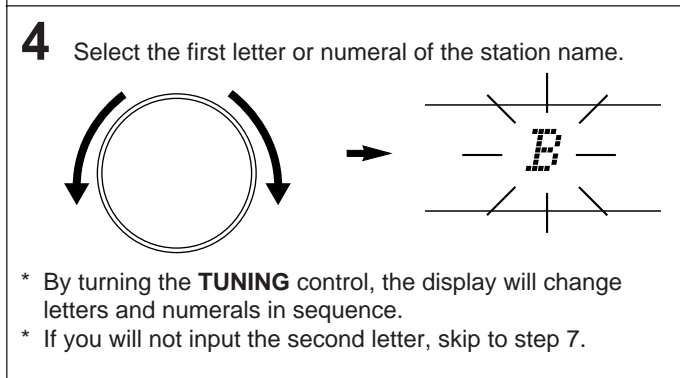
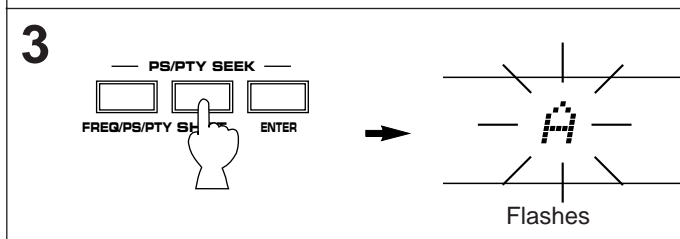
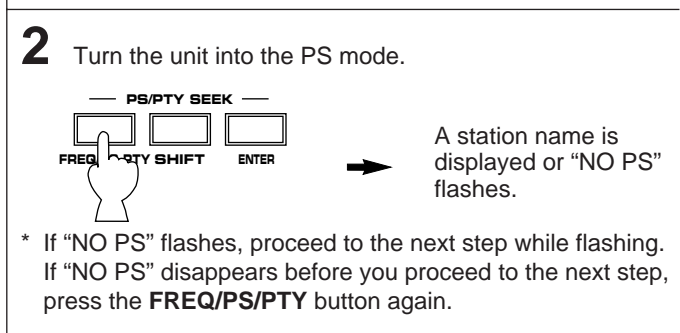
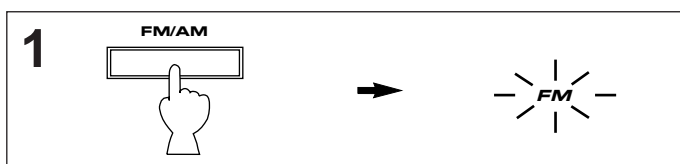
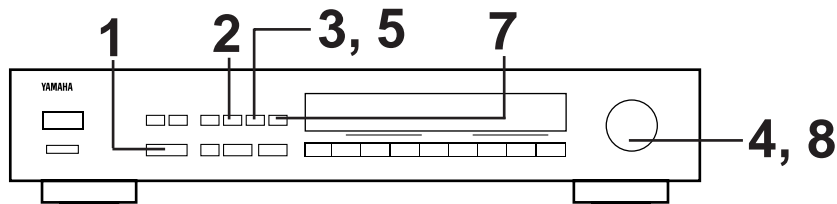

### You do not have to input a full name for searching the station

You may input only the first letter of the station name. In this case, you can skip steps 5 and 6. In step 8, the unit searches and calls a nearest station which has the letter you input. If the station is not the desired one, turn the **TUNING** control again. The unit will begin searching another station which has the letter.

### To cancel this function

Press the **AF**, **FREQ/PS/PTY**, **SHIFT**, **ENTER**, **FM/AM** or **MEMORY** button.

### Notes

- If no station is found by this function after searching through all preset stations, "NO PS" flashes for about 3 seconds on the display, and then it returns to the mode which had been obtained before the searching was performed.
- This function is useful especially for calling a station with weak signals which cannot be received by the automatic tuning method. By only storing such a station, you can call it any time easily.

## Calling a preset RDS station by the program type (PTY SEEK)

By designating a program type, the unit automatically searches RDS stations of that program type from among all preset stations.

\* There are 15 program types to classify RDS stations. For details, refer to page 13.

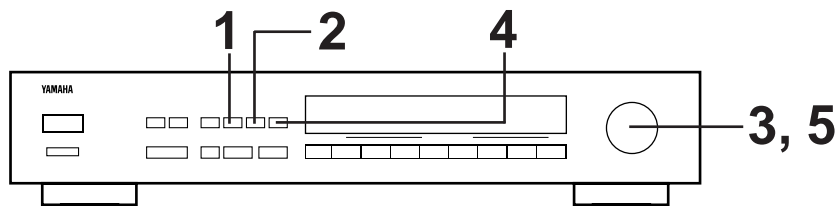

**1** Turn the unit into the PTY mode.

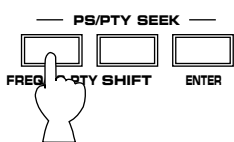

Press once or twice until a program type is displayed or "NO PTY" flashes.

\* If "NO PTY" flashes, proceed to the next step while flashing. If "NO PTY" disappears before you proceed to the next step, press the **FREQ/PS/PTY** button once or twice.

**2**

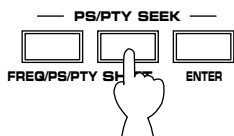

The program type of the station now being received or "NEWS" flashes on the display.

**3** Select the desired program type.

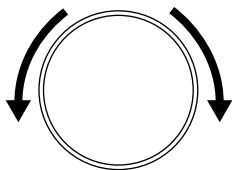

\* By turning the **TUNING** control, the display will change program types in sequence.

**4** When the desired program type appears, press the **ENTER** button.

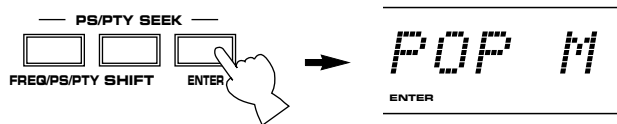

Lights up.

**5**

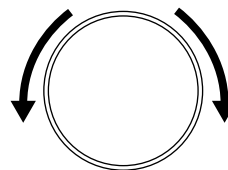

Slightly turn.

The unit begins searching among all preset stations, and calls a station of the program type if such a station is found.

\* When the **TUNING** control is turned clockwise, the search is performed from "A1" toward higher numbers of the preset stations (A1, A2 ... A8, B1, B2, ...). If, however, "A3" is currently being called for example, the search begins from the next station "A4".

When the **TUNING** control is turned counterclockwise, the search is performed in reverse order.

If the called station is not the desired one, turn the **TUNING** control again to search for another station of the same program type.

### To cancel this function

Press the **AF**, **FREQ/PS/PTY**, **SHIFT**, **ENTER**, **FM/AM** or **MEMORY** button.

### Note

If no station is found by this function, after searching through all preset stations, "NO PTY" flashes for about 3 seconds on the display, and then it returns to the mode which had been obtained before the searching was performed.



## Calling the best quality RDS station which broadcasts the same program (AF SEEK)

This function automatically searches and calls another RDS station of the best reception quality which broadcasts the same program now you are listening to.

This function utilizes AF (Alternative Frequencies for the same program station) and PI (Program Identification) of RDS data service. The search is carried out among the RDS network stations.

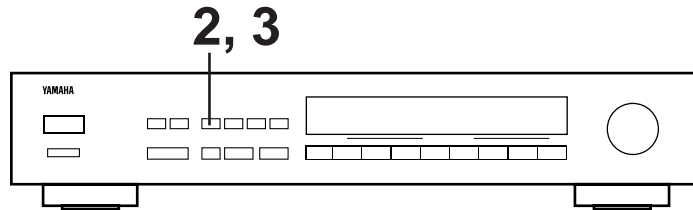

- 1** Tune to a desired RDS station.  
\* Wait for about 10 seconds before proceeding to the next step. This is for making this unit carry out searching from among more stations.

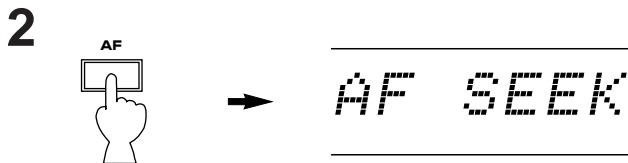

The unit searches other stations with the same program throughout network stations.

- \* If the station is not an RDS station, or there is no other station with the same program, "NO AF" flashes.



Stations with the same program are all stored and numbered from the best quality station in sequence.

AF SEEK1  
↓  
AF SEEK2  
⋮  
↓  
AF SEEK5

After the search is finished, the best quality station is called.

- 3** If desired, you can call the second station by pressing the **AF** button.



Whenever the **AF** button is pressed, stored stations are called in sequence.

When pressed after the last station is selected, the first one is restored.

### To cancel this function

Press a button other than the **AF** button.  
All of the stored stations will be also cleared.

# REMOTE CONTROL TRANSMITTER (separate purchase)

## Functions

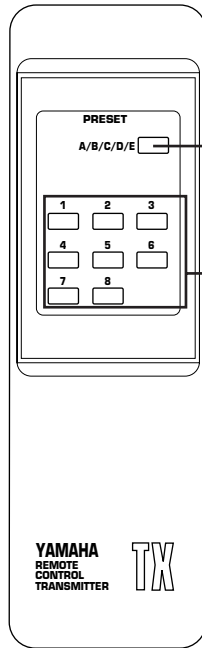

### A/B/C/D/E

Selects a desired page (A–E) of the preset station buttons.  
(Refer to “PRESET TUNING” on page 9.)

### Preset station buttons

Used to store stations or recall stored stations.  
(Refer to “PRESET TUNING” on page 9.)

## Battery installation

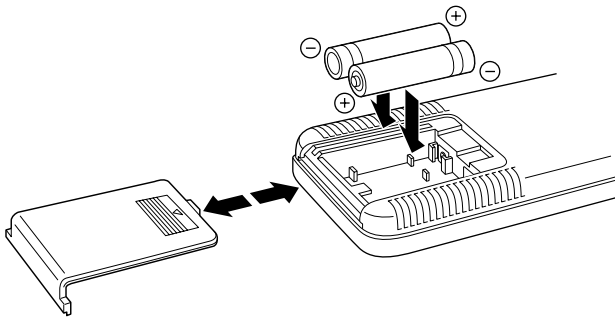

## Battery replacement

If you find that the remote control transmitter must be used closer to the main unit, the batteries are weak. Replace both batteries with new ones.

### Notes

- Use only AA, R6, UM-3 batteries for replacement.
- Be sure the polarities are correct. (See the illustration inside the battery compartment.)
- Remove the batteries if the remote control transmitter will not be used for an extended period of time.
- If batteries leak, dispose of them immediately. Avoid touching the leaked material or letting it come in contact with clothing, etc. Clean the battery compartment thoroughly before installing new batteries.

## Remote control transmitter operation range

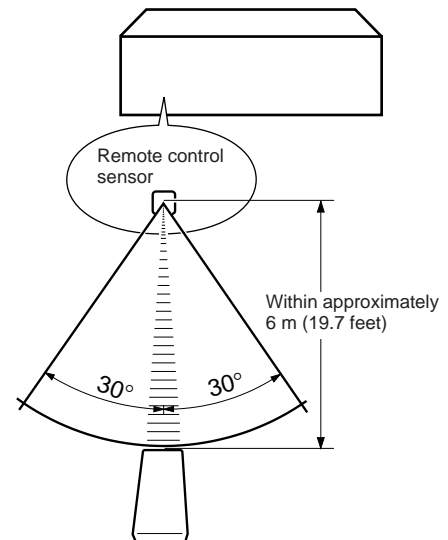

### Notes

- There should be no large obstacles between the remote control transmitter and the main unit.
- If the remote control sensor is directly illuminated by strong lighting (especially an inverter type of fluorescent lamp etc.), it might cause the remote control transmitter not to work correctly. In this case, reposition the main unit to avoid direct lighting.

# TROUBLESHOOTING

If the unit fails to operate normally, check the following points to determine whether the fault can be corrected by the simple measures suggested. If it cannot be corrected, or if the fault is not listed in the SYMPTOM column, disconnect the power cord and contact your authorized YAMAHA dealer or service center for help.

	SYMPTOM	CAUSE	REMEDY
FM	<b>Crackling sounds from time to time (especially in weak signal areas).</b>	Ignition noise from passing vehicles.	The FM antenna should be put up as high as possible, away from the road, and a coaxial cable used.
		Noise from thermostats or other electrical equipment.	Attach a noise suppressor to the equipment causing the noise.
	<b>FM stereo reception is noisy.</b>	Because of the characteristics of FM stereo broadcasts, this is limited to cases where the transmitter is far away or the antenna input is poor.	Check the antenna connections. Try using a high quality directional FM antenna. Set the TUNING MODE button to the manual tuning mode.
	<b>The STEREO indicator flickers and reception is noisy.</b>	Insufficient antenna input.	Use an antenna appropriate for the reception condition in your area.
		Not tuned correctly.	Tune again.
	<b>There is distortion and clear reception cannot be obtained even with a good FM antenna.</b>	There is multi path interference.	Adjust antenna placement to eliminate multi-path interference.
	<b>No stereo effect even with a stereo broadcast.</b>	The TUNING MODE button is set to the manual tuning mode.	Set the button properly.
	<b>A desired station cannot be tuned in with Automatic tuning.</b>	The station is too weak.	Use the manual tuning mode. Set the IF MODE NARROW/WIDE button correctly. Use a high quality directional FM antenna.
<b>Previously preset stations can no longer be tuned in.</b>	The tuner has been unplugged for a long period.	Repeat the presetting procedure.	
AM	<b>Insufficient sensitivity.</b>	Weak signal or loose antenna connections.	Tighten the AM loop antenna connections and rotate it for best reception.
	<b>A desired station cannot be tuned in with Automatic tuning.</b>		Use the manual tuning mode.
	<b>There are continuous crackling and hissing noises.</b>	These noises result from lightning, fluorescent lamps, motors, thermostats and other electrical equipment.	Use an outdoor antenna and a ground wire. This will help somewhat but it is difficult to eliminate all noise.
	<b>There are buzzing and whining noises (especially in the evening).</b>	Another station is interfering with the received station.	This is impossible to remedy.
A television set is being used nearby.		Move the television away.	

# SPECIFICATIONS

## FM SECTION

Tuning Range	
[U.K. and Europe models].....	87.5 to 108 MHz
50 dB Quieting Sensitivity (IHF) [U.K. model]	
75 ohms Mono .....	1.55 $\mu$ V (15.1 dBf)
75 ohms Stereo (NARROW) .....	21 $\mu$ V (37.7 dBf)
Usable Sensitivity	
[U.K. model]	
75 ohms, 1 kHz, 100% mod. (30 dB S/N Quieting)	
.....	0.8 $\mu$ V (9.3 dBf)
[Europe model] (DIN)	
75 ohms Mono (S/N 26 dB) .....	0.8 $\mu$ V
75 ohms Stereo (S/N 46 dB) .....	22 $\mu$ V
Image Response Ratio	
[U.K. model] .....	40 dB
[Europe model] .....	75 dB
IF Response Ratio	
[U.K. model] .....	90 dB
[Europe model] .....	75 dB
Spurious Response Ratio.....	70 dB
AM Suppression Ratio.....	55 dB
Capture Ratio .....	1.5 dB
Alternate Channel Selectivity (NARROW)	
[U.K. model] .....	85 dB
Selectivity (two signals, 40 kHz Dev., $\pm$ 300 kHz, NARROW)	
[Europe model only].....	70 dB
Signal-to-Noise Ratio	
[U.K. model] (IHF)	
Mono.....	90 dB
Stereo .....	85 dB
[Europe model] (DIN-NOISE RMS)	
Mono (40 kHz Dev.).....	83 dB
Stereo (40 kHz Dev.) .....	79 dB
Harmonic Distortion (1 kHz, WIDE)	
[U.K. model]	
Mono/Stereo .....	0.02%/0.03%
[Europe model (40 kHz Dev.)]	
Mono/Stereo .....	0.02%/0.03%
Stereo Separation (WIDE)	
[U.K. model].....	1 kHz 52 dB
[Europe model (40 kHz Dev.)] .....	1 kHz 45 dB

## Frequency Response

[U.K. model]	
30 Hz to 13 kHz.....	0 $\pm$ 0.5 dB
20 Hz to 15 kHz.....	0 $\pm$ 1.5 dB
[Europe model]	
20 Hz to 15 kHz.....	0 $\pm$ 0.5 dB

## AM SECTION

### Tuning Range

[U.K. and Europe models]	
.....	531 to 1,611 kHz

Usable Sensitivity .....	100 $\mu$ V/m
Selectivity .....	32 dB
Signal-to-Noise Ratio.....	50 dB
Image Response Ratio .....	40 dB
Spurious Response Ratio.....	50 dB
Harmonic Distortion; 400 Hz.....	0.3%

## AUDIO SECTION

### Output Level/Impedance

FM (100 % mod. 1 kHz)	
[U.K. model].....	700 mV/1 k-ohms
FM (40 kHz Dev.)	
[Europe model] .....	600 mV/1 k-ohms
AM (30% mod. 400 Hz).....	180 mV/1 k-ohms

## GENERAL

### Power Supply

U.K. model.....	240V, 50 Hz
Europe model .....	230V, 50 Hz

Power Consumption .....

.....	11W
Dimensions (W x H x D) .....	435 x 86 x 291 mm
	(17-1/8" x 3-3/8" x 11-7/16")

Weight .....

.....	3.5 kg (7 lbs. 11 oz.)
Accessories .....	Audio connection cord
	AM loop antenna/Indoor FM antenna

\* Specifications subject to change without notice.

# YAMAHA

---

YAMAHA ELECTRONICS CORPORATION, USA 6660 ORANGETHORPE AVE., BUENA PARK, CALIF. 90620, U.S.A.  
YAMAHA CANADA MUSIC LTD. 135 MILNER AVE., SCARBOROUGH, ONTARIO M1S 3R1, CANADA  
YAMAHA ELECTRONIK EUROPA G.m.b.H. SIEMENSSTR. 22-34, 25462 RELINGEN BEI HAMBURG, F.R. OF GERMANY  
YAMAHA ELECTRONIQUE FRANCE S.A. RUE AMBROISE CROIZAT BP70 CROISSY-BEAUBOURG 77312 MARNE-LA-VALLEE CEDEX02, FRANCE  
YAMAHA ELECTRONICS (UK) LTD. YAMAHA HOUSE, 200 RICKMANSWORTH ROAD WATFORD, HERTS WD1 7JS, ENGLAND  
YAMAHA SCANDINAVIA A.B. J A WETTERGRENS GATA 1, BOX 30053, 400 43 VÄSTRA FRÖLUNDA, SWEDEN  
YAMAHA MUSIC AUSTRALIA PTY, LTD. 17-33 MARKET ST., SOUTH MELBOURNE, 3205 VIC., AUSTRALIA

YAMAHA CORPORATION  
VQ43170-0 BWWO, G Printed in Japan